

paper model No. 908e

small eight-pointed star

Difficulty: medium



diameter 16,4 cm

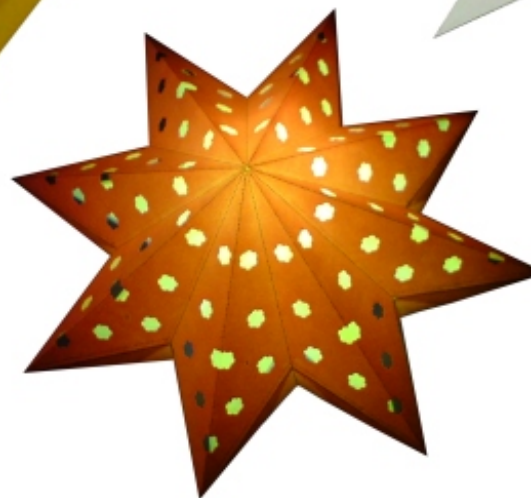
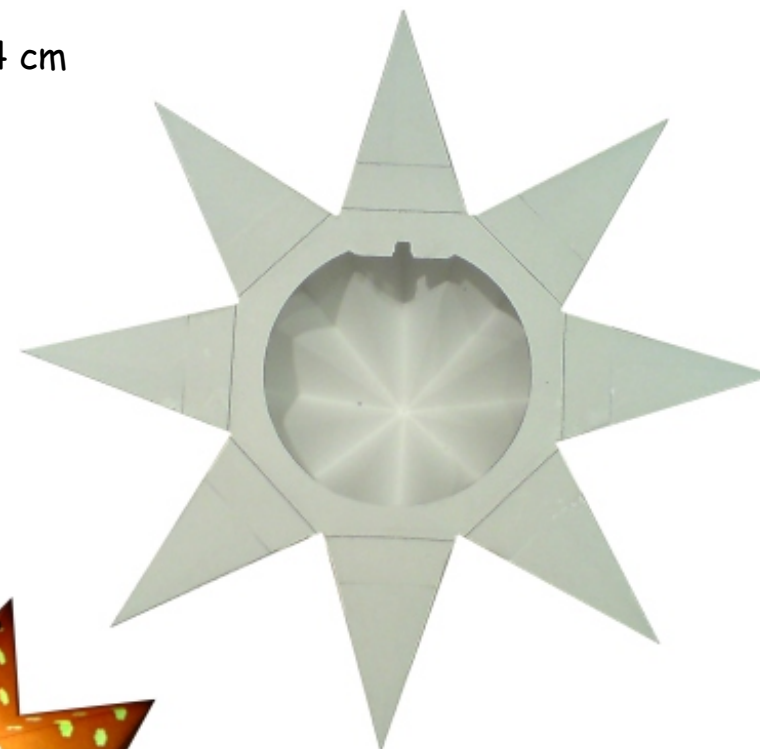

Copyright 2006-2011 Boris Voigt, Berlin-Hohenschönhausen  
© certain rights reserved  
You aren't allowed to make alterations of this construction paper.  
Here the sale of these construction papers is prohibited.  
The distribution of these construction papers free of charge is allowed.



**Projekt Bastelbogen**

[www.projekt-bastelbogen.de](http://www.projekt-bastelbogen.de)

small eight-pointed star

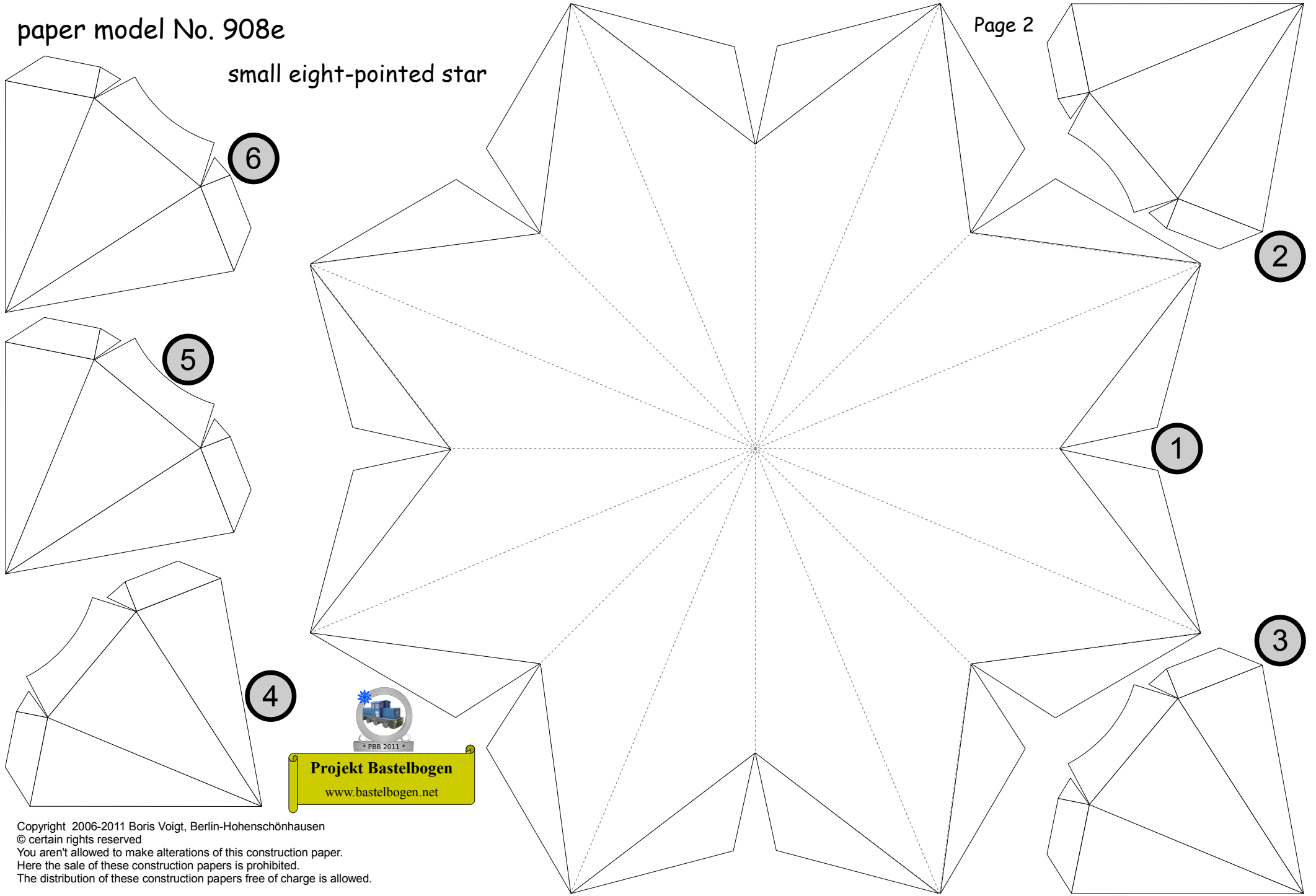

small eight-pointed star

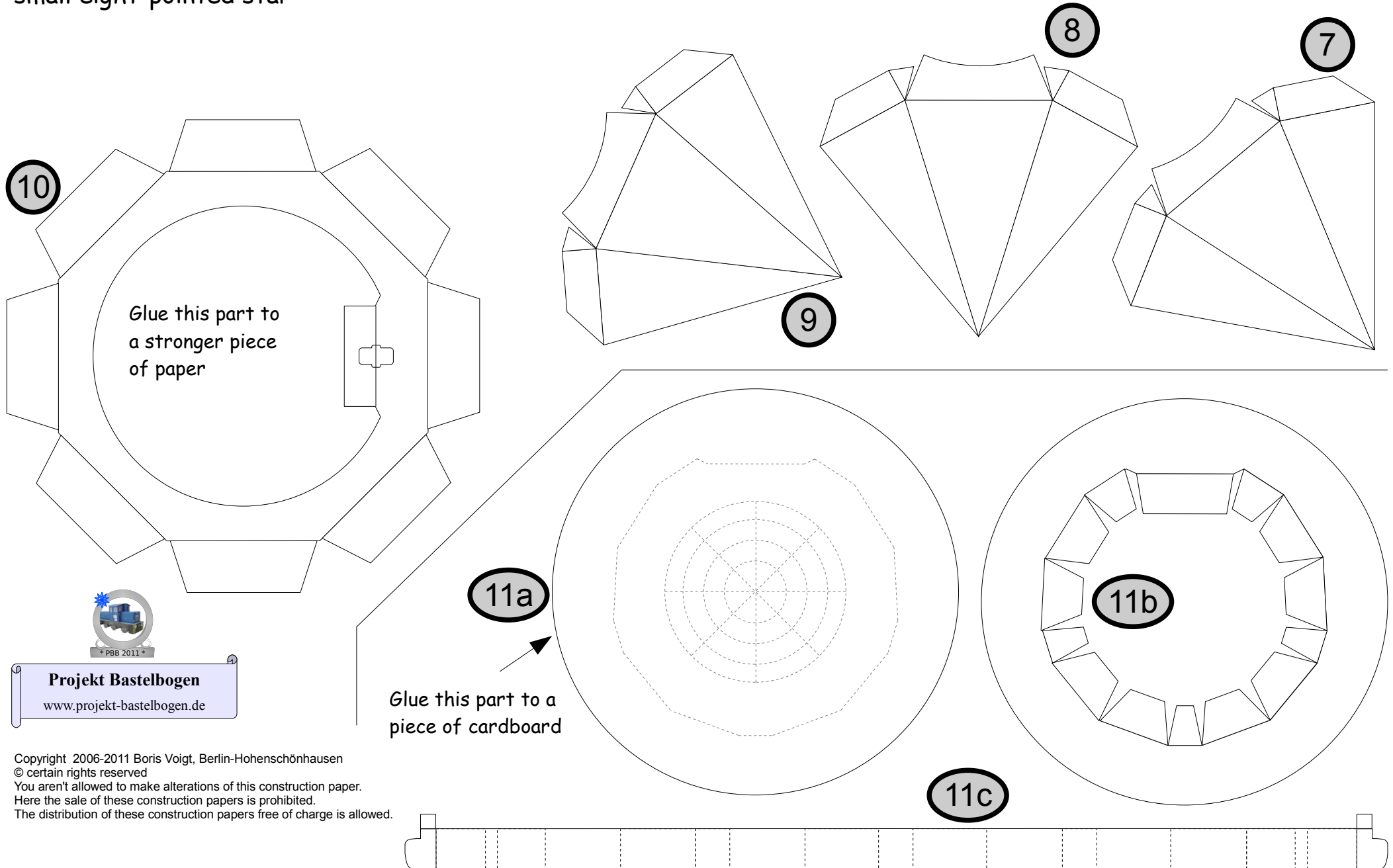

**Projekt Bastelbogen**

[www.projekt-bastelbogen.de](http://www.projekt-bastelbogen.de)

small eight-pointed star:

Part 10 is rotated by 22.5 °

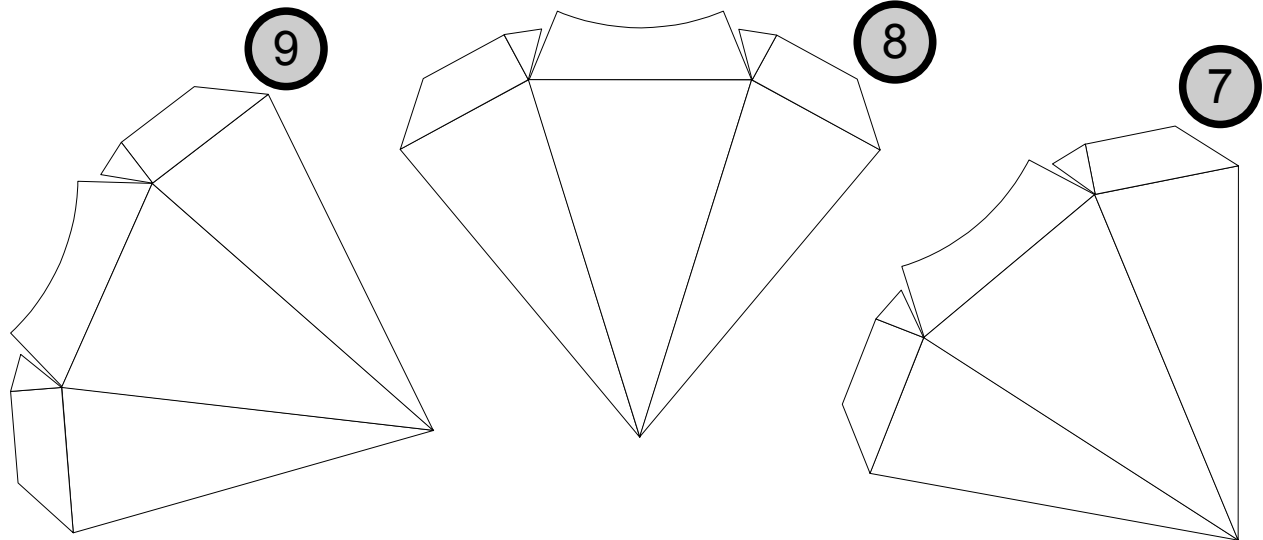
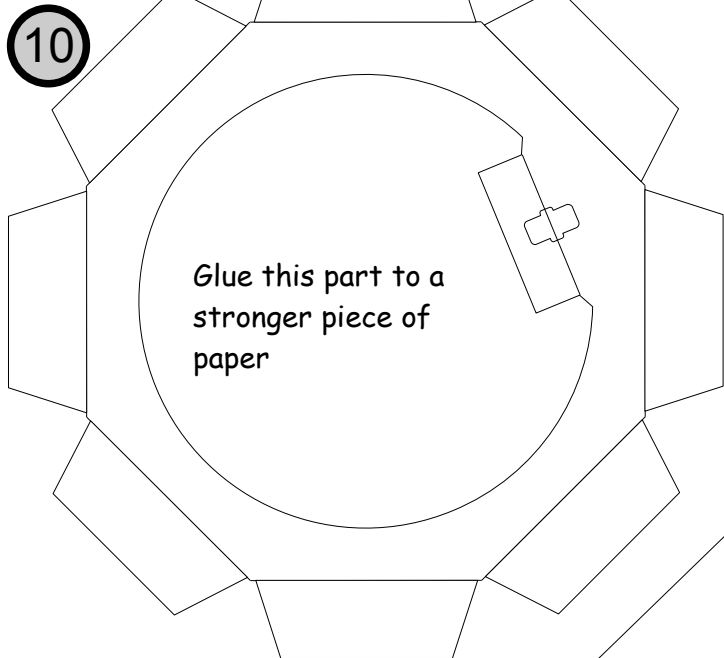

**Projekt Bastelbogen**

[www.projekt-bastelbogen.de](http://www.projekt-bastelbogen.de)

Copyright 2006-2011 Boris Voigt, Berlin-Hohenschönhausen  
© certain rights reserved  
You aren't allowed to make alterations of this construction paper.  
Here the sale of these construction papers is prohibited.  
The distribution of these construction papers free of charge is allowed.

11a

Glue this part to a piece of cardboard

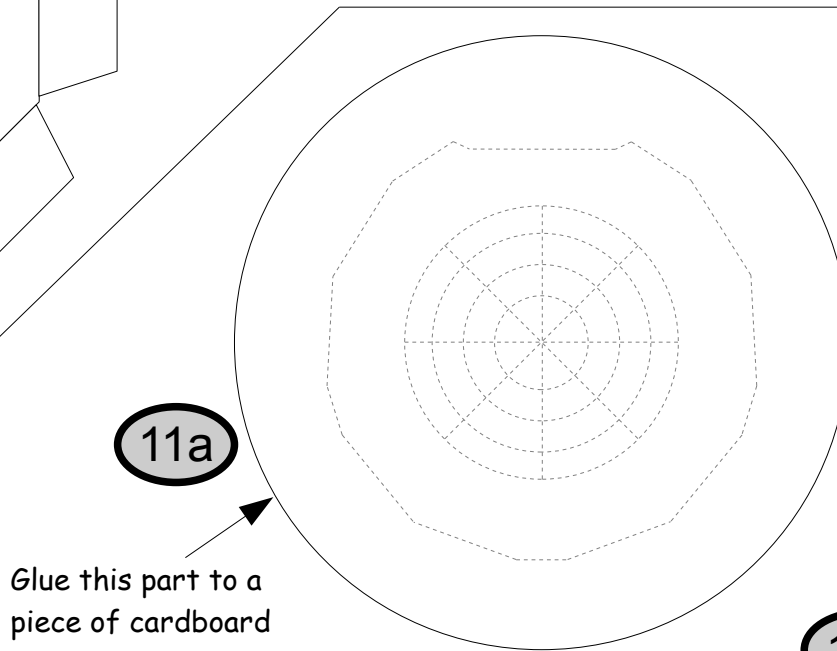

11b

11c

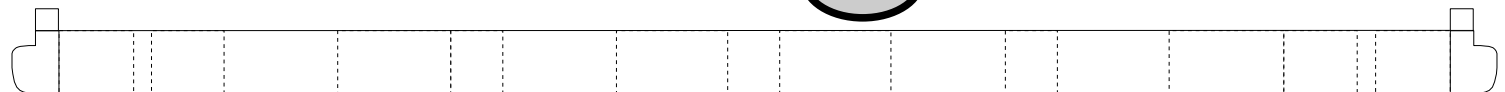
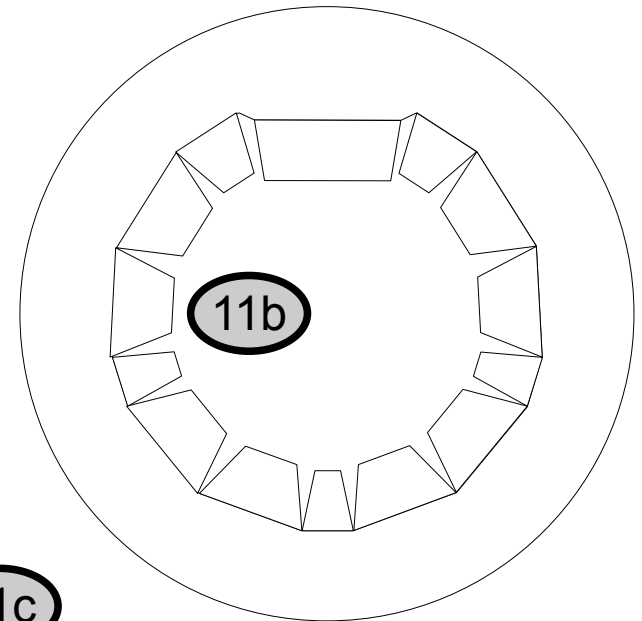

Profile: Benchmark 1:1

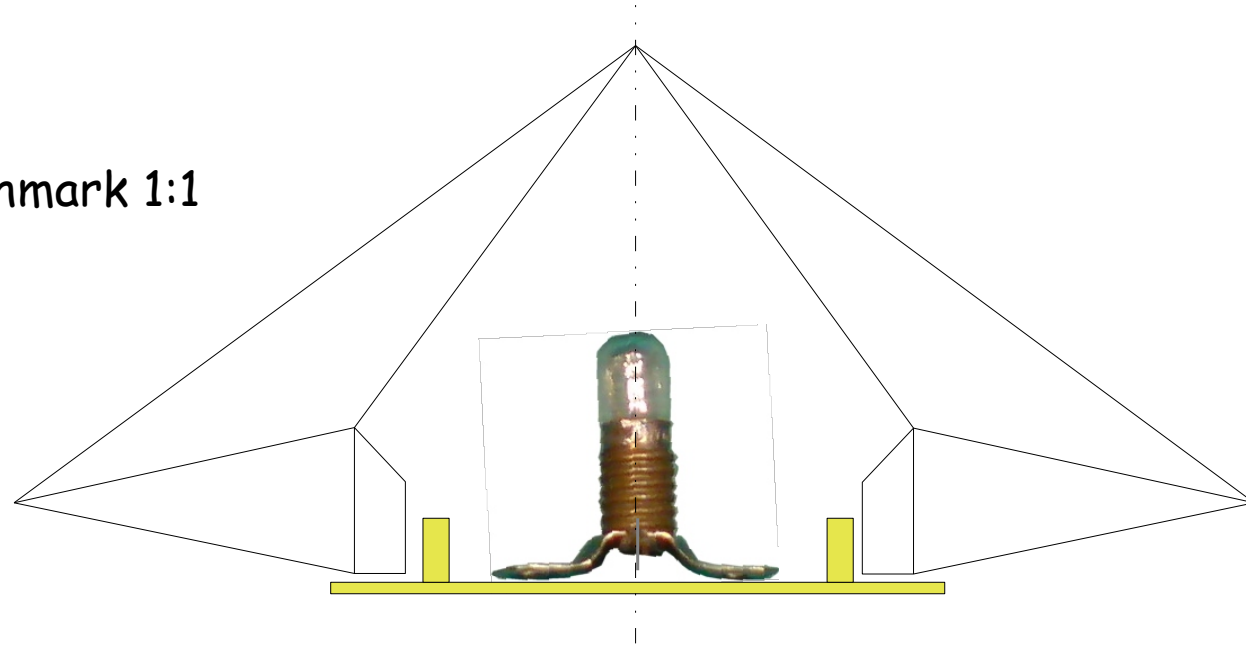

small eight-pointed star: template

for punching the paper with  
punch pliers

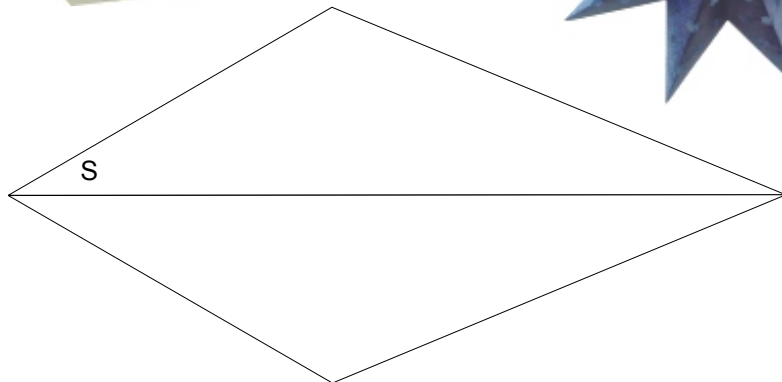

for a silhouette

